

RevNo	Revision note	Date	Signature	Checked
0	GENERAL REVISION		IP	IP

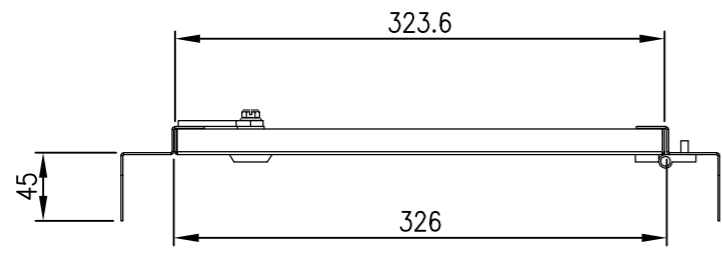

TOP VIEW

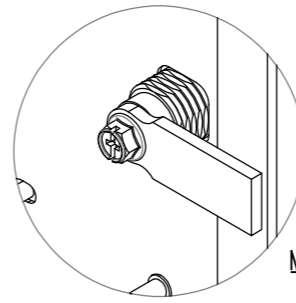

LOCKSET SPOT DETAIL

M6x10 STUD WELD (x1)

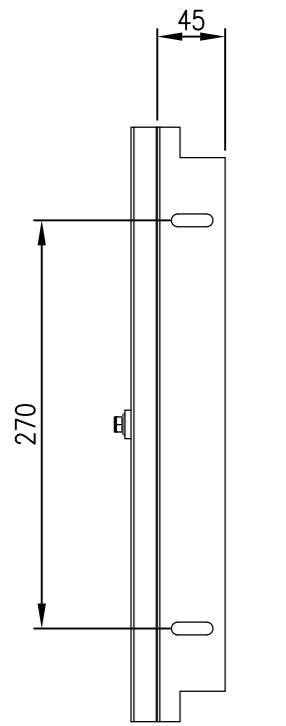
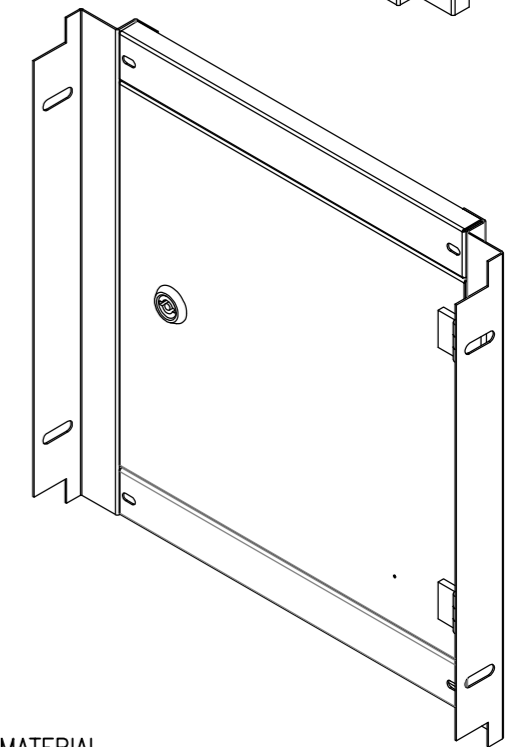
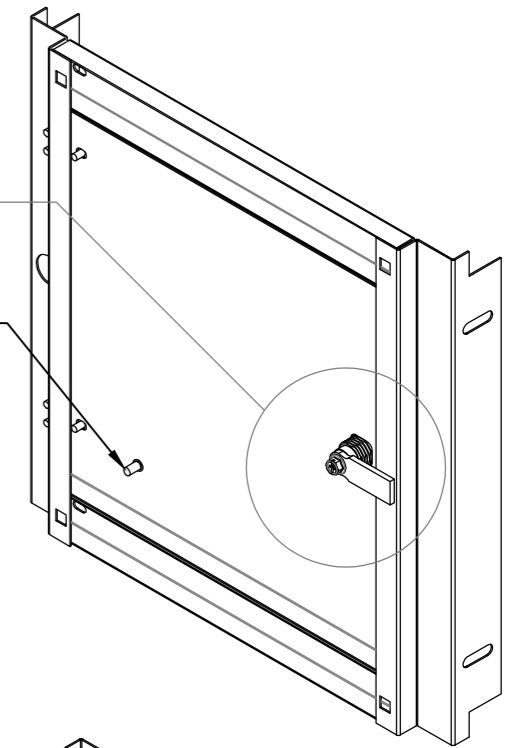

LEFT SIDE VERTICAL FRAME

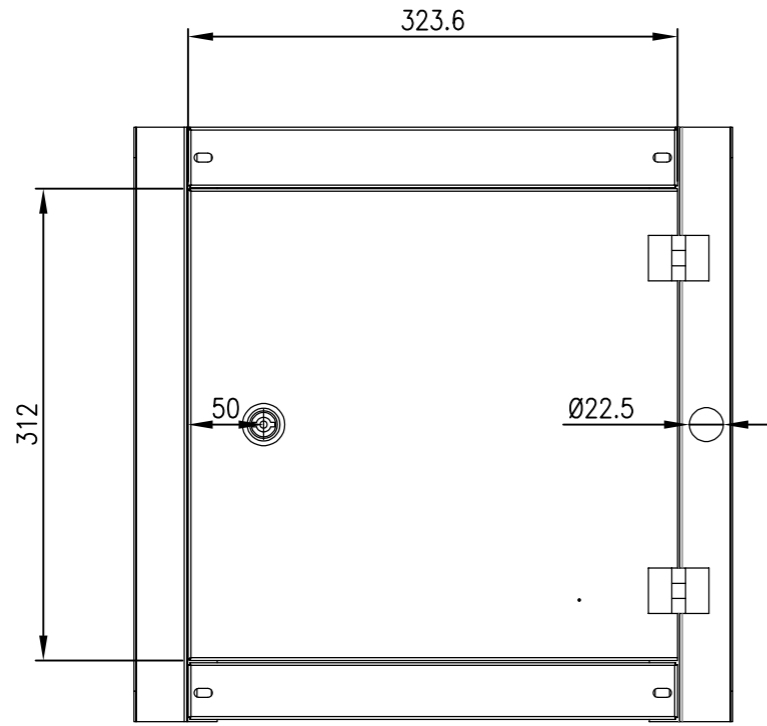

FRONT VIEW

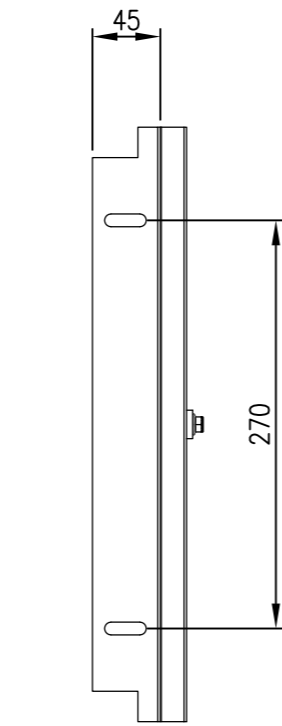

RIGHT SIDE VERTICAL FRAME

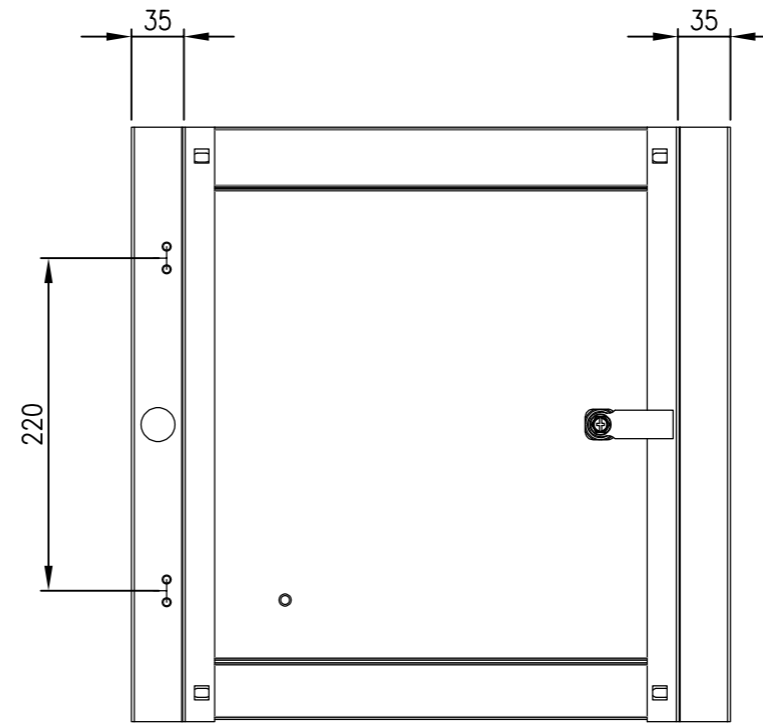

REAR VIEW

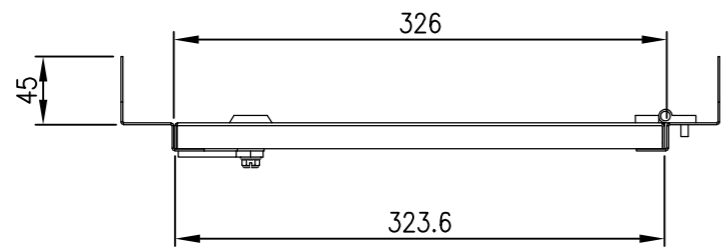

BOTTOM VIEW

MATERIAL
 FRAME: 1.2mm GALVANISED STEEL
 DOOR PANEL: 1.2mm GALVANISED STEEL

CLEARANCE/DISTANCE DIMENSIONS:
 -INNER DOOR TO OUTER DOOR: 68.3mm
 -INNER DOOR TO MOUNTING PLATE:
 -(ENCLOSURE WITH 200 DEPTH): 117.8mm
 -(ENCLOSURE WITH 300 DEPTH): 217.8mm

© IP ENCLOSURES 2022.
 THIS DRAWING SHALL NOT BE COPIED OR REPRODUCED
 WITHOUT AUTHORISATION FROM IP ENCLOSURES.
 www.ipenclosures.com.au

Itemref	Quantity	Title/Name, designation, material, dimension etc	Article No./Reference
Designed by IP	Checked by IP	Approved by - date 01/07/22	Filename IP-PSID4040
Date 01/07/22		Scale 1:5	
IP Enclosures			400Hx400W STEEL INNER DOOR
IP-PSID4040		Edition 0	Sheet 1/1